

21-18IL

Original Instructions

GENERAL WARNINGS & DISPOSAL



To reduce the risk of injury, the user must read the instruction manual.



This symbol is used throughout this manual to warn the user about potential risks. Please read & understand these sections before using the device.



Personal Protective Equipment (P.P.E.), such as ear defenders, eye protection, safety gloves and a dust mask, must be worn during the operation of the device.



The device must not be exposed to rain or immersed in water.



Do not allow any part of the device to come into contact with flames, or to catch fire.



Do not expose battery pack or tool to fire or excessive temperatures.



Do not dispose of batteries in household waste. Return exhausted batteries to a local collection or recycling point.

Li

This product has been marked with a symbol relating to removing electric and electronic waste. The product should not be discarded with household waste but must be returned to a collection system which conforms to the EU Directive 2012/19/EU or UK Waste Electrical and Electronic Equipment Regulations 2013. It will then be recycled or dismantled in order to reduce the impact on the environment. Electric and electronic equipment can be hazardous for the environment and for human health since they contain hazardous substances.



The month and year of manufacture can be found within the product serial number e.g. MMYPPPAXXXXX. Where production month (MM) and production year (YY) are included.



Contents

GENERAL POWER TOOL SAFETY WARNINGS	4
1. Work area safety	4
2. Electrical safety	4
3. Personal safety	4
4. Power tool use and care	5
5. Battery tool use and care	5
6. Service	6
CHARGER SAFETY	7
COMPONENT LIST	8
TOOL TECHNICAL DATA	9
OPERATING INSTRUCTIONS	11
Intended Use	11
Battery	11
Turning On/ Off	12
To Hang the Inspection Light	12
Adjustable Head	12
Maintenance	12
Transport and Storage	13
WARRANTY STATEMENT	14
Terms and Conditions	14
EU/UK DECLARATION OF CONFORMITY	16



GENERAL POWER TOOL SAFETY WARNINGS

WARNING!

Read all safety warnings, instructions and specifications provided with this power tool. Failure to follow all instructions listed below may result in electric shock, fire and/or serious injury. **Save all warnings and instructions for future reference.**

The term “power tool” in the warnings refers to your mains operated (corded) power tool or battery operated (cordless) power tool.

1. Work area safety

- **Keep work area clean and well lit.**
Cluttered or dark areas invite accidents.
- **Do not operate power tools in explosive atmospheres, such as in the presence of flammable liquids, gases or dust.** Power tools create sparks which may ignite the dust or fumes.
- **Keep children and bystanders away while operating a power tool.** Distractions can cause you to lose control.

2. Electrical safety

- **Power tool plugs must match the outlet. Never modify the plug in any way. Do not use any adapter plugs with earthed (grounded) power tools.** Unmodified plugs and matching outlets will reduce risk of electric shock.
- **Avoid body contact with earthed or grounded surfaces, such as pipes, radiators, ranges and refrigerators.** There is an increased risk of electric shock if your body is earthed or grounded.
- **Do not expose power tools to rain or wet conditions.** Water entering a power tool will increase the risk of electric shock.

- **Do not abuse the cord. Never use the cord for carrying, pulling or unplugging the power tool. Keep the cord away from heat, oil, sharp edges or moving parts.**
Damaged or entangled cords increase the risk of electric shock.
- **When operating a power tool outdoors, use an extension cord suitable for outdoor use.** Use of a cord suitable for outdoor use reduces the risk of electric shock.
- **If operating a power tool in a damp location is unavoidable, use a residual current device (RCD) protected supply.**
Use of an RCD reduces the risk of electric shock.

3. Personal safety

- **Stay alert, watch what you are doing and use common sense when operating a power tool. Do not use a power tool while you are tired or under the influence of drugs, alcohol or medication.** A moment of inattention while operating power tools may result in serious personal injury.
- **Use personal protective equipment. Always wear eye protection.** Protective equipment such as a dust mask, non-skid safety shoes, hard hat or hearing protection used for appropriate conditions will reduce personal injuries.
- **Prevent unintentional starting. Ensure the switch is in the off position before connecting to power source and/or battery pack, picking up or carrying the tool.** Carrying power tools with your finger on the switch or energising power tools that have the switch on invites accidents.

- **Remove any adjusting key or wrench before turning the power tool on.** A wrench or a key left attached to a rotating part of the power tool may result in personal injury.
 - **Do not overreach. Keep proper footing and balance at all times.** This enables better control of the power tool in unexpected situations.
 - **Dress properly. Do not wear loose clothing or jewellery. Keep your hair and clothing away from moving parts.** Loose clothes, jewellery or long hair can be caught in moving parts.
 - **If devices are provided for the connection of dust extraction and collection facilities, ensure these are connected and properly used.** Use of dust collection can reduce dust-related hazards.
 - **Do not let familiarity gained from frequent use of tools allow you to become complacent and ignore tool safety principles.** A careless action can cause severe injury within a fraction of a second.
- 4. Power tool use and care**
- **Do not force the power tool. Use the correct power tool for your application.** The correct power tool will do the job better and safer at the rate for which it was designed.
 - **Do not use the power tool if the switch does not turn it on and off.** Any power tool that cannot be controlled with the switch is dangerous and must be repaired.
 - **Disconnect the plug from the power source and/or remove the battery pack, if detachable, from the power tool before making any adjustments, changing accessories, or storing power tools.** Such preventive safety measures reduce the risk of starting the power tool accidentally.
- **Store idle power tools out of the reach of children and do not allow persons unfamiliar with the power tool or these instructions to operate the power tool.** Power tools are dangerous in the hands of untrained users.
 - **Maintain power tools and accessories. Check for misalignment or binding of moving parts, breakage of parts and any other condition that may affect the power tool's operation. If damaged, have the power tool repaired before use.** Many accidents are caused by poorly maintained power tools.
 - **Keep cutting tools sharp and clean.** Properly maintained cutting tools with sharp cutting edges are less likely to bind and are easier to control.
 - **Use the power tool, accessories and tool bits etc. in accordance with these instructions, taking into account the working conditions and the work to be performed.** Use of the power tool for operations different from those intended could result in a hazardous situation.
 - **Keep handles and grasping surfaces dry, clean and free from oil and grease.** Slippery handles and grasping surfaces do not allow for safe handling and control of the tool in unexpected situations.
- 5. Battery tool use and care**
- **Recharge only with the charger specified by the manufacturer.** A charger that is suitable for one type of battery pack may create a risk of fire when used with another battery pack.
 - **Use power tools only with specifically designated battery packs.** Use of any other battery packs may create a risk of injury and fire.



- › **When the battery pack is not in use, keep it away from other metal objects, like paper clips, coins, keys, nails, screws or other small metal objects that can make a connection from one terminal to another.**

Shorting the battery terminals together may cause burns or a fire.

- › **Under abusive conditions, liquid may be ejected from the battery; avoid contact. If contact accidentally occurs, flush with water. If liquid contacts eyes, additionally seek medical help.**

Liquid ejected from the battery may cause irritation or burns.

- › **Do not use a battery pack or tool that is damaged or modified.** Damaged or modified batteries may exhibit unpredictable behaviour resulting in fire, an explosion or risk of injury.

- › **Do not expose a battery pack or tool to fire or excessive temperature.** Exposure to fire or temperature above 130 °C may cause explosion.

- › **Follow all charging instructions and do not charge the battery pack or tool outside the temperature range specified in the instructions.** Charging improperly or at temperatures outside the specified range may damage the battery and increase the risk of fire.

6. Service

- › **Have your power tool serviced by a qualified repair person using only identical replacement parts.** This will ensure that the safety of the power tool is maintained.

- › **Never service damaged battery packs.**

Service of battery packs should only be performed by the manufacturer or authorized service providers.

CHARGER SAFETY

WARNING!

Read all safety warnings, instructions and specifications provided with the charger. Failure to follow all instructions listed below may result in electric shock, fire and/or serious injury. **Save all warnings and instructions for future reference.**

- > **To reduce risk of injury, only charge JCB rechargeable batteries.** The charger and battery packs are specifically designed to work together. Other types of batteries may burst causing fire and personal injury.
- > **Do not allow any liquid to get inside the charger.** Electric shock may result.
- > **Do not expose the charger to rain or snow.**
- > **Under certain conditions with the charger plugged into the power supply, the exposed charging contacts inside the charger can be shorted by foreign materials.** Foreign materials of a conductive nature such as, but not limited to, steel, wool, aluminium foil or any buildup of metallic particles should be kept away from charger cavities.
- > **Always unplug the charger from the power supply when there is no battery in the cavity.**
- > **Unplug the charger from the power supply before attempting to clean.**
- > **Do not operate the charger with a damaged cord or plug.** Have them replaced immediately.
- > **The charger is designed to operate on standard 230-240V AC household electrical power. Do not attempt to use it on any other voltage.**
- > **This appliance can be used by children aged from 8 years and above and persons with reduced physical, sensory or mental capabilities or lack of experience and knowledge if they have been given supervision or instruction concerning use of the appliance in a safe way and understand the hazards involved.**
Children shall not play with the appliance. Cleaning and user maintenance shall not be made by children without supervision.
- > **If the supply cord is damaged, it must be replaced by the manufacturer, its service agent or similarly qualified persons in order to avoid a hazard.**



COMPONENT LIST

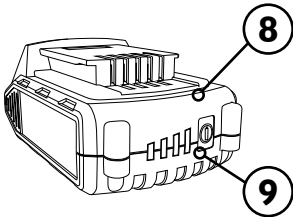
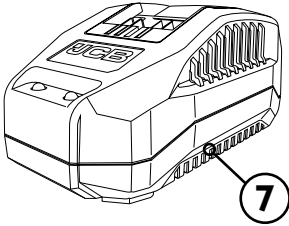

Battery size shown for illustrative purposes only

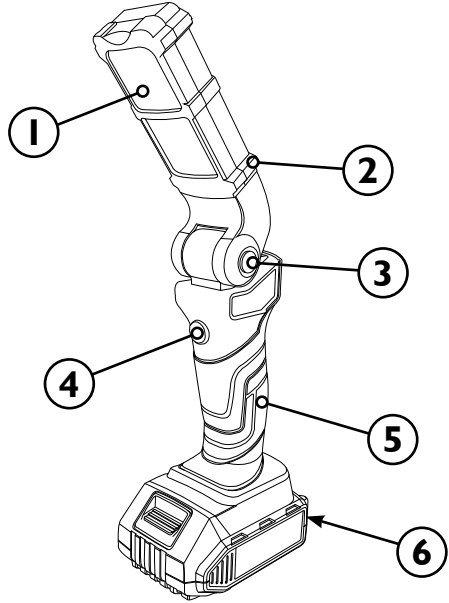

1. SPOTLIGHT
2. SWIVEL JOINT
3. ANGLE JOINT
4. ON/ OFF SWITCH
5. GRIP
6. J HOOK (NOT VISIBLE)
7. CHARGER*
8. BATTERY PACK* - PLEASE REFER TO TABLE ON PAGE 11 FOR BATTERY INFORMATION
9. BATTERY TEST BUTTON AND CHARGE INDICATOR*

*If applicable

TOOL TECHNICAL DATA

Power	18V d.c.
Spotlight	3W COB LED
Lumens	220
Swivel Torch Head	0 - 270°
Swivel Torch Head Stops	0, 45, 90, 135, 180, 225 & 270°
Angle Torch Head	0 - 180°
Angle Positive Stops	0, 30, 60, 90, 120, 150 & 180°
Run Time	> 13hrs (2.0Ah), >20hrs (3.0Ah), >26hrs (4.0Ah), >33hrs (5.0Ah)
Dimensions (L x W x H)	225 x 65 x 65mm
Product Weight (Body only, w/o battery)	0.3 kg

LITHIUM ION BATTERY TECHNICAL DATA

Battery Code	Battery Size	Voltage	Battery Capacity	Charge Time (Fast Charger)	Charge Time (Super Fast Charger)	Charge Time (Dual Charger)
21-20LI	Small	18V	2.0Ah	45 mins	30 mins	35 mins
21-30LI	Large	18V	3.0Ah	65 mins	40 mins	45 mins
21-40LI	Large	18V	4.0Ah	90 mins	55 mins	60 mins
21-50LI	Large	18V	5.0Ah	110 mins	65 mins	75 mins

Times given as a guide only. Battery charge and discharge times dependant on age, usage and condition.

CHARGER TECHNICAL DATA

Charger Code	Input Power	Output
21-18VFC	220-240V AC, 50-60Hz, 70W	14.4 - 18V d.c. 2.4A
21-18VSFC	220-240V AC, 50-60Hz, 105W	14.4 - 18V d.c. 4.0A
21-18VDC	100-240V AC, 50-60Hz, 200W	20.5V d.c. 2 x 3.5A



OPERATING INSTRUCTIONS

Intended Use

A general purpose LED inspection light for the illumination of most work area spaces.

The tool must not be modified or used for any other purposes than the ones described in these instructions.

Battery

NOTE

Make sure the power switch is not pressed in when inserting or replacing the battery. Use JCB batteries only: 21-20LI, 21-30-LI, 21-40LI and 21-50LI.

- **Do not force the battery when connecting it, use moderate pressure.** An incorrectly connected battery can damage the battery terminals or the battery socket on the tool.
- Use the button on the battery to check the charging status; 4 red LEDs indicates fully charged, where 1 indicates low battery status.

Charging The Battery







WARNING!

After charging for the first time, ensure the battery is completely discharged before placing on charge again. Repeat this charging and discharging cycle 4 to 5 times to ensure battery is correctly conditioned.

- Place the battery charger on a level and stable surface. Plug the charger into a suitable power point.
- Connect the battery to the charger so that it clicks into place.

- Refer to the Battery Charge Level table below for battery charger status as indicated by LED lights.
- When the battery pack is fully charged, unplug the charger and remove the battery pack.

Battery Charge Level

Red LED	Green LED	Battery Charge Status
		Charger is connected to mains power
		Connected battery is charging
		Connected battery is fully charged
		Connected battery has a charging fault
		Charger is outside correct operating temperature range (<0°C / >40°C)

If the LEDs on the charger do not come on when charging:

- Check that the charger's mains plug is properly plugged into the power point and that the charger is switched on
- Check that the battery is correctly inserted in the charger

Connecting the battery

- Connect the battery to the battery socket on the tool so that it clicks into place.

Removing the battery

- Press the battery release button and remove the battery from the tool.

Turning On/Off

WARNING!

Do not direct the light beam at persons or animals and do not stare into the light beam yourself (not even from a distance). Staring into the light beam may result in serious injury or vision loss.

- Press the ON/OFF button to turn the inspection light on and off.

WARNING!

The inspection light lamps can get very hot. Keep the inspection light away from combustible or fragile materials, as close contact between the lamps and other materials may cause damage to the inspection light, melt materials, or start fires.

To Hang the Inspection Light

WARNING!

Only hang or mount the inspection light in a suitable area, free from obstructions. Do not hang the inspection light from any loose cord or live electrical power cord. Ensure the inspection light is securely installed to prevent a falling object hazard. Failure to follow these instructions can result in electric shocks or other serious personal injuries.

- Fold the inspection light in half at the joint.
- Lift the J hook from the slot.
- Use the J hook to hang the inspection light.

Adjustable Head

- The inspection light head can be set in a variety of positions by means of the swivel & universal joints.

WARNING!

Do not place hands or fingers between adjustable head and frame when positioning inspection light to avoid trapping your fingers or hands.

Maintenance

WARNING!

Switch off the tool and disconnect the power (remove battery/unplug) before cleaning and maintenance. This helps avoid the risk of electric shocks and accidental starting.

- Wipe the tool with a dry or damp cloth. **Do not use a wet cloth. Do not use detergent that contains solvent or corrosive, abrasive additives.** This risks damaging the surfaces of the tool.
- Clear the tool vents and the lamp covers of dust and dirt after each use. **Do not clean ventilation holes by inserting sharp objects in them, such as screwdrivers and other similar objects.**
- Stubborn contamination in areas hard to access can be removed with compressed air (max 3. bar).
- Regularly check all fasteners, screws and bolts to make sure that they are tight. Tighten any loose screws immediately or serious injury could occur.





WARNING!

Never open the tool. The tool has no internal parts that the user can service or repair. Never try to repair the tool yourself. Take to an authorised service centre.

Transport and Storage

- › If the tool will remain unused for any length of time, it should be stored in the original packaging.
- › Store the tool and battery in a dry, frost-free, well ventilated place.
- › Keep all tools out of the reach of children.
- › Always switch off the tool and disconnect it from the power supply (remove the battery/unplug the power cord) before transport.
- › Always carry the tool using the purpose-designed handle.
- › Ensure that the tool is not at risk of tipping over or exposed to excessive vibration and shocks during transport, especially if the tool will be transported by car or other vehicle.

NOTE

Operating temperature: 0-40 °C
Storage temperature: 20-60 °C



WARRANTY STATEMENT

JCB Power Tools are guaranteed against manufacturing defects for up to 3 years from date of purchase by simply registering your product online within 30 days. Proof of purchase required. This does not affect your statutory rights.

To register your JCB Power Tool, please visit: jcb-tools.com

Online registration is required within 30 days to receive a warranty certificate to activate your standard 3 year warranty. Registration is only available online via www.jcb-tools.com. You will need your original sales receipt, the model number and the serial number (if applicable) of your product. Kits comprising of two or more tools are excluded from single registration and must be registered individually for full warranty cover.

Upon successful registration, a warranty certificate will be available to download, print or save as a PDF document. The relevant warranty certificate together with the original sales receipt will be required in the event of any claim within the warranty period.

Should you choose not to register your product within 30 days of purchase, your statutory consumer rights will not be affected. You will need the original sales receipt as proof of purchase in the event of a warranty claim.

Warranty cover commences from the date of purchase on the retail sales receipt and is valid only for JCB Tools products purchased within the UK bearing the CE and UKCA mark and a visible serial number.

In the unlikely event your JCB Power Tool is subject to a manufacturing fault within the warranty period, JCB Tools may repair the product by replacing defective parts free of charge at our discretion. In the event parts are irreplaceable JCB Tools may replace your product free of charge. The original product will remain the property of JCB Tools in this situation.

The above repair or replacement of products will be undertaken providing that:

- The product has been subject to fair wear and tear only.
- The product has not been subject to accidental or cosmetic damage.

- The product has not been misused and has been used only in accordance with the instruction manual provided.
- The product has not been subject to overload or insufficient servicing and maintenance.
- The product has not been subject to any abnormal environmental conditions or inappropriate operating conditions.
- Repairs have not been attempted by an unauthorised person and no modifications have been made to the product.
- Repairs have not been undertaken using non-genuine spare parts.

JCB Power Tools used for Hire Fleets or as part of B2B and Service Contracts are not covered by these terms and conditions.

JCB Tools 3 Year Warranty excludes the following (where applicable):

- Components normally subject to wear such as carbon brushes.
- Batteries, Chucks and Chargers.
- Accessories and consumable items.
- Cases and tool storage products.

If your product develops a fault within 30 days of purchase, return it to the retailer where it was purchased together with your sales receipt. If a product develops a fault after 30 days a warranty claim must be submitted.

If you have a warranty claim please take your product, original sales receipt and if applicable, a copy of your extended warranty certificate to your place of purchase or nearest JCB Tools retailer.

If you wish to send your product to us directly, please send to JCB Tools, Unit 55, Romsey Industrial Estate, Greatbridge Road, Romsey, Hampshire, SO51 0HR, along with your original receipt and, if applicable, a copy of your extended warranty certificate. Delivery and repair charges may apply at our discretion should the warranty claim be invalid for any of the reasons illustrated above. In the event charges are not accepted the product will be retained by JCB Tools and remain the property of JCB Tools.

The information on both your sales receipt and your extended warranty certificate must match.

JCB TOOLS WILL NOT BE LIABLE FOR ANY INJURIES OR CONSEQUENTIAL DAMAGES RESULTING FROM USE OF THIS PRODUCT.



EU DECLARATION OF CONFORMITY				UK DECLARATION OF CONFORMITY
1.	PRODUCT(S) COVERED BY THIS DECLARATION:	Product: UK Product Code No. EU Product Code No. Factory Reference No.	JCB 18V Cordless LED Inspection Light JCB-18IL-B, 21-18IL-B JCB-18IL-B-E PLCL-768	Batch Number: P.O.
2.	IDENTIFICATION DETAILS OF MANUFACTURER:	Name: Address: Country:	Yellow & Black Tools Ltd. (T/A: JCB Tools) Unit 55 Romsey Industrial Estate, Greatbridge Road Romsey, Hampshire SO51 0HR UK	
	AUTHORISED REPRESENTATIVE:	Name: Address: Country:	Authorised Representative Service 77 Camden Street Lower Dublin DO2 XE80 Ireland	
THIS DECLARATION OF CONFORMITY IS ISSUED UNDER THE SOLE RESPONSIBILITY OF THE MANUFACTURER				
4.	OBJECT OF THE DECLARATION:	Product: Function:	18V Cordless Inspection Light Illumination of Work Areas and Workpieces	
5i.	THE OBJECT OF THE DECLARATION DESCRIBED IN POINT 4 IS IN CONFORMITY WITH THE RELEVANT UNION HARMONISATION LEGISLATION:	2001/95/EC	General Product Safety Directive	
		2014/30/EU	The Electromagnetic Compatibility Directive	
		2011/65/EU	The Restriction of Hazardous Substances Directive	
5ii.	THE OBJECT OF THE DECLARATION DESCRIBED IN POINT 4 IS IN CONFORMITY WITH THE RELEVANT UK STATUTORY INSTRUMENTS:	2005 No. 1803	The General Product Safety Regulations 2005	
		2016 No. 1091	The Electromagnetic Compatibility Regulations 2016	
		2012 No. 3032	The Restriction of the Use of Certain Hazardous Substances in Electrical and Electronic Equipment Regulations 2012	
6.	REFERENCES TO THE RELEVANT HARMONISED SAFETY STANDARDS USED OR REFERENCES TO THE OTHER TECHNICAL SPECIFICATIONS IN RELATION TO WHICH CONFORMITY IS DECLARED:	EN 60598-1:2015+A1 EN 60598-2-4:2018 EN 62493:2015 EN 55014-1:2017 EN 55014-2:2015 EN 62471:2008	Luminaires. General requirements and tests Luminaires. Particular requirements. Portable general purpose luminaires Assessment of lighting equipment related to human exposure to electromagnetic field Electromagnetic compatibility. Requirements for household appliances, electric tools and similar apparatus. Emission Electromagnetic compatibility. Requirements for household appliances, electric tools and similar apparatus. Immunity. Photobiological safety of lamps and lamp systems	
7.	ADDITIONAL INFORMATION. THE TECHNICAL DOCUMENTATION FOR THE MACHINERY IS AVAILABLE FROM:	Name: Address: Country:	Authorised Representative Service 77 Camden Street Lower Dublin DO2 XE80 Ireland	
SIGNED FOR AND ON BEHALF OF: PLACE OF ISSUE: DATE OF ISSUE (DD/MM/YYYY): NAME: FUNCTION: SIGNATURE:		GREAT STAR EUROPE LTD. ROMSEY, UK. 07/06/2021 TIM BURGOWNE QA MANAGER 		